

Name: _____

Addition, Subtraction, Multiplication and Division.

$12 + 9 =$	$12 + 9 =$	$2 + 11 =$	$24 + 4 =$
$24 + 6 =$	$40 + 8 =$	$6 \times 1 =$	$56 + 7 =$
$0 + 6 =$	$20 + 5 =$	$13 - 7 =$	$16 + 4 =$
$7 \times 6 =$	$16 - 10 =$	$13 - 6 =$	$11 - 1 =$
$1 + 2 =$	$72 + 9 =$	$7 \times 7 =$	$1 + 2 =$
$6 + 10 =$	$3 \times 0 =$	$5 + 12 =$	$4 + 7 =$
$18 + 9 =$	$2 \times 6 =$	$1 \times 8 =$	$11 + 12 =$
$11 - 1 =$	$5 + 4 =$	$14 + 7 =$	$4 \times 6 =$
$3 + 9 =$	$8 - 1 =$	$7 + 7 =$	$8 + 9 =$
$21 + 3 =$	$9 - 4 =$	$9 \times 1 =$	$9 - 0 =$
$4 + 5 =$	$3 \times 8 =$	$12 + 8 =$	$12 - 8 =$
$11 - 7 =$	$2 \times 5 =$	$0 + 7 =$	$9 \times 4 =$
$45 + 9 =$	$11 - 3 =$	$12 - 8 =$	$14 - 5 =$
$8 \times 7 =$	$18 + 6 =$	$72 + 9 =$	$12 - 9 =$
$35 + 7 =$	$2 + 12 =$	$5 \times 5 =$	$9 - 3 =$
$15 - 9 =$	$11 - 7 =$	$5 \times 3 =$	$4 + 1 =$
$24 + 4 =$	$30 + 5 =$	$9 \times 5 =$	$3 \times 3 =$
$3 + 3 =$	$16 + 8 =$	$7 + 10 =$	$5 \times 4 =$
$14 + 2 =$	$2 + 2 =$	$4 + 4 =$	$17 - 9 =$
$6 + 1 =$	$9 \times 6 =$	$0 \times 2 =$	$8 + 7 =$
$5 \times 6 =$	$5 - 3 =$	$10 + 2 =$	$12 - 6 =$
$15 - 5 =$	$9 + 8 =$	$16 - 7 =$	$18 - 10 =$
$6 \times 3 =$	$8 + 0 =$	$8 - 2 =$	$2 \times 3 =$
$36 + 6 =$	$17 - 8 =$	$8 + 1 =$	$1 + 4 =$
$8 - 1 =$	$4 + 6 =$	$13 - 3 =$	$0 \times 4 =$

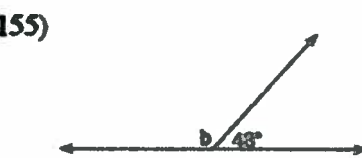
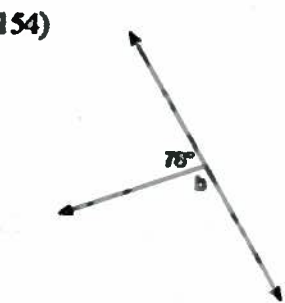
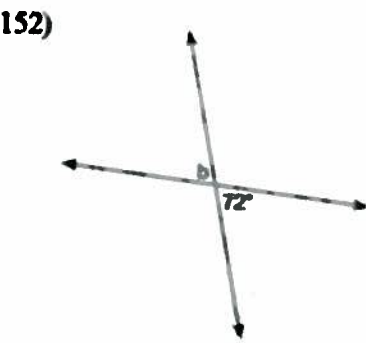
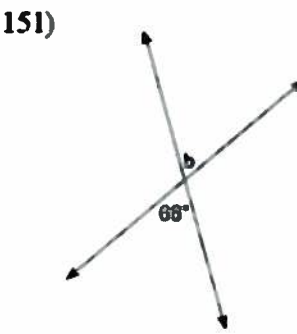
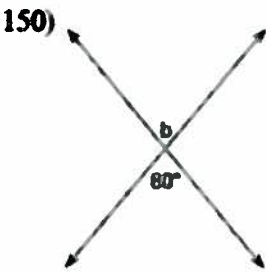
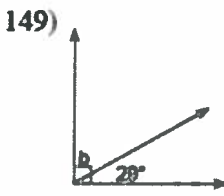
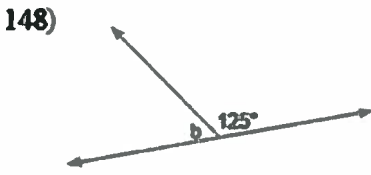
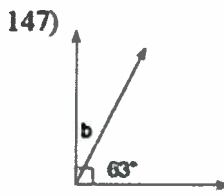
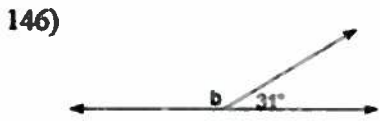
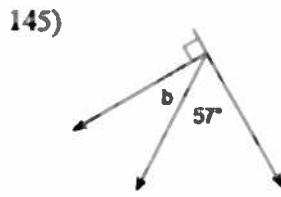
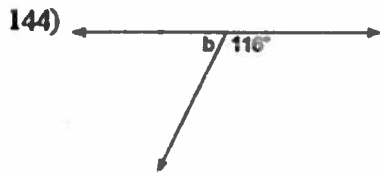

47)

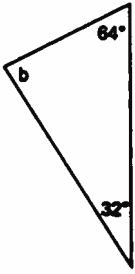

48)

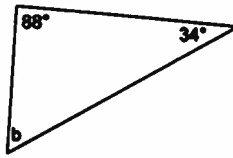

49)

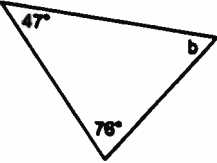

50)

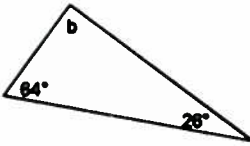

51)

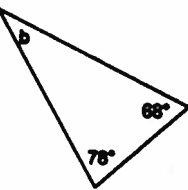

52)

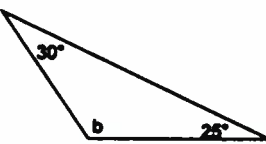

53)

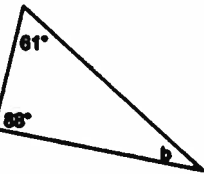

54)



55)

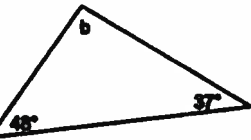

56)

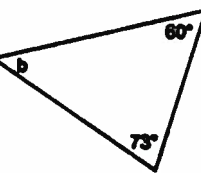

57)



58)

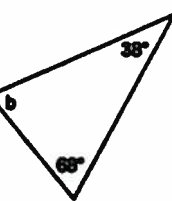

13)

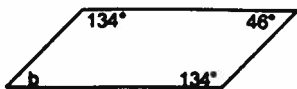

14)

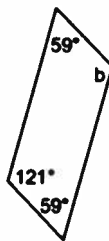

15)

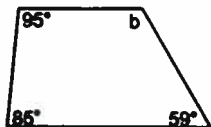

16)

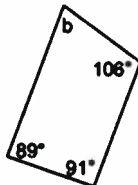

17)

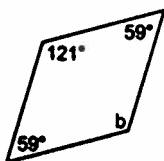

18)

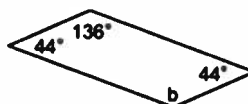

19)

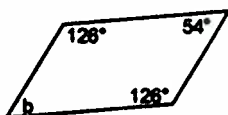

20)

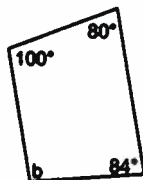

21)

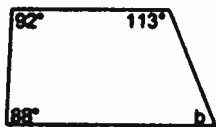

22)

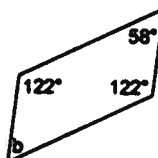

23)

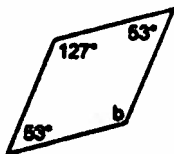

24)



25)

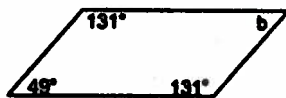

26)

